

Protecta PLUS™ Child Harness

Series Number: 220/2010



Booster Seat

For use with compatible Booster Seats for children from approximately 4 years of age up to the maximum age as stated on the Booster Seat.



Vehicle Seat

For children approximately 7 years of age up to approximately 10 years of age when used with a lap only seat belt.

Instructions for Installation & Use



IMPORTANT:
KEEP THIS BOOKLET IN A SAFE PLACE FOR FUTURE
REFERENCE.

Page

- 3 INTRODUCTION
- 4 INFORMATION
- 5 WARNINGS
- 6 SUITABLE FOR USE
- 7 HOW TO INSTALL & USE:
WITH CONVERTIBLE BOOSTER SEAT
- 20 HOW TO INSTALL & USE:
WITH BASIC BOOSTER SEAT
- 23 HOW TO INSTALL & USE:
WITH CAR'S SEAT
- 29 CORRECT FITMENT
- 30 NEXT TYPE OF RESTRAINT
- 31 PRE-INSTALLATION
- 32 PRE-INSTALLATION ANCHOR FITTING
- 35 IN CASE OF ACCIDENT
- 36 CONTACT DETAILS

The Protecta PLUS™ Harness is suitable for child use on a vehicle seat or in conjunction with any booster seat or booster cushion. It has also been specifically designed for use with the Safe-n-Sound Protecta PLUS™ Harness and Versa Tether™ compliant Booster Seats and Convertible Booster Seats to provide a safe and secure fit for the child.

Child Harnesses should be used in conjunction with a compatible booster seat by children aged at least 4 whose shoulders are above the lower shoulder height marker, to at least 7 and as either a stand-alone restraint or with a compatible booster by children at least 7 to approximately 10 years. Children should continue to use a booster until their shoulders reach the upper shoulder height marker.

Do not use this restraint until child's shoulders are above the lower shoulder height marker on the booster seat. Children are safest in a booster.

Correct use of this product can significantly reduce a child's risk of injury.

This restraint must be used with a lap or lap-sash seatbelt in accordance with these instructions.

Protect all webbing from abrasion and cutting by sharp corners and edges.

DO NOT USE IF THE CHILD WEIGHS OVER 36kg.

THIS RESTRAINT MUST BE ATTACHED TO A CHILD RESTRAINT ANCHORAGE POINT IN THE CAR. REFER TO CAR OWNERS HANDBOOK FOR LOCATION OF ANCHORAGE POINTS. REFER TO A CHILD RESTRAINT FITTING STATION IF NO ANCHORAGE POINTS ARE IN THE MOTOR CAR.

WHEN USED WITH JUST A SEATBELT, THIS CHILD HARNESS IS TO BE USED WITH A LAP ONLY SEAT BELT IN THE BACK OF MOST CARS WITH FORWARD FACING SEATS.

IF USED WITH A BOOSTER SEAT OR CONVERTIBLE BOOSTER SEAT THEN EITHER A LAP OR A LAP-SASH SEATBELT MAY BE USED WITH THE CHILD HARNESS.

These instructions show the installation of the Child Harness for use with a:

- Booster Seat or Convertible Booster seat and a lap or lap-sash seatbelt (page 7).
- Car's seat and a lap only seat belt (page 23).

Safe-n-Sound recommend that all Booster Seats and Convertible Booster Seats use the SLIDEGUARD™ clip to ensure the Child Harness fits correctly and the child does not slump under the car's lap seat belt. Lap seat belt on the child's abdomen is dangerous.

CAREFULLY READ AND FOLLOW ALL OF THE INSTRUCTIONS FOR INSTALLATION. INSTALL IN STRICT ACCORDANCE WITH THESE INSTRUCTIONS FOR MAXIMUM SAFETY. IF IN DOUBT ABOUT THE CORRECT METHOD OF INSTALLATION PLEASE CONTACT BRITAX CHILDCARE, OR AGENT OR A CHILD RESTRAINT FITTING STATION AUTHORIZED BY THE STATE GOVERNMENT BODY. IN NEW ZEALAND, CONTACT THE AGENT FOR THE VEHICLE.

No child restraint can guarantee absolute protection from injury in every crash. However, to ensure that your child gets all the protection designed into the Protecta PLUS™ Harness please READ AND FOLLOW THESE INSTRUCTIONS EXACTLY and use only Safe-n-Sound recommended parts and accessories.

This Child Harness may be used in conjunction with Booster Seats and Convertible Booster Seats that recommend this Child Harness. Some Safe-n-Sound™, Babylove™, Hipod™ and Cargo™ child restraints only use this harness. Read the Booster Seat or Convertible Seat instruction book or packaging to confirm which harness you need.

UPPER ANCHORAGE

This Child Harness requires the upper anchorage strap to be connected to a child restraint anchor fitting in the car. Recent cars include an anchor fitting where as older cars will require the fitting to be installed. Check your car owners handbook for the location of the car's child restraint anchor fitting or anchorage point. If there is no fitting then read pages 31 to 34. An anchor fitting is provided with this product if there is no anchor fitting in the car.



CHOOSING METHOD OF INSTALLATION

The harness may be used with compatible Booster Seats or Convertible Booster Seats, using either the car's lap only seat belt or the lap sash seat belt until the child is too large for the booster seat that is, the child's shoulders reach the Upper Shoulder Height Marker (see pages 7 to 22).

The harness can be used with a lap only seat belt in a car for children 7 years of age and over (See pages 23 to 28).

DO NOT USE IF THE CHILD WEIGHS OVER 36kg.

Use the restraint exactly as shown in the instructions.

Supervision of children is needed because they may be able to undo buckles & adjusters.

Do not alter or modify this restraint.

Repairs must only be done by the manufacturer or agent.

Do not allow the restraint to come into contact with polishes, oils, bleach & other chemicals.

Destroy the restraint if it has been in a severe crash, even if no damage is visible.

The lap portion of the belt must be adjusted firmly first, and then the harness, so that the belt is not lifted off the child's lap when the harness is adjusted.

DO NOT USE THIS HARNESS IF THE CHILD'S SHOULDERS ARE ABOVE THE TOP OF THE CAR SEAT BACK OR HEADREST (Unless child is seated on a booster seat with head support above the car seat back).

Do not use the extension strap supplied for any other purpose.

Straps may be damaged by unsecured cargo in a collision. Secure or remove hazardous cargo before using this strap. Hatch-back or wagon: Do not use the child restraint where this strap may fall into a split in the seat back.

A seat belt extender should not be used if the seat belt is not long enough to secure the child. If a seat belt extender is used then the buckle must not be in contact with the child.

⚠️ WARNING:

DO NOT LEAVE CHILDREN UNATTENDED IN THE CAR.

INSTALLATION AND USE

THIS RESTRAINT MUST BE ATTACHED TO A CHILD RESTRAINT ANCHORAGE POINT IN THE CAR. REFER TO CAR OWNERS HANDBOOK FOR LOCATION OF ANCHORAGE POINTS. REFER TO A CHILD RESTRAINT FITTING STATION IF NO ANCHORAGE POINTS ARE IN THE MOTOR CAR.

TO BE USED WITH A LAP ONLY SEAT BELT IN THE BACK OF MOST CARS WITH FORWARD FACING SEATS.

TO BE USED WITH A LAP ONLY SEAT BELT IN THE BACK OF MOST CARS WITH FORWARD FACING SEATS. IF USED WITH A BOOSTER SEAT THEN EITHER A LAP OR LAP-SASH SEATBELT MAY BE USED WITH THE CHILD HARNESS.

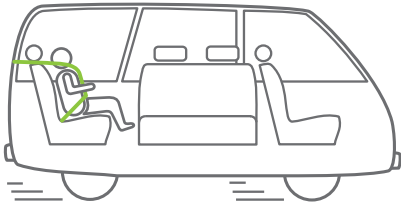

TO BE USED WITH A LAP OR LAP-SASH SEAT BELT IN THE BACK OF MOST CARS WITH FORWARD-FACING SEATS.

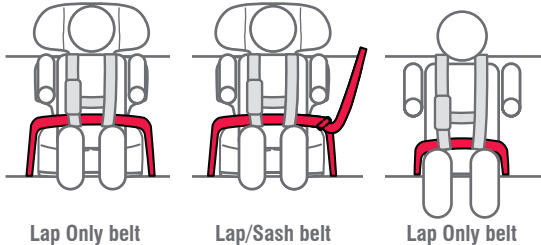

Lap Only belt

Lap/Sash belt

Lap Only belt



To be used only in a forward-facing position. Suitable for use when the child's shoulders are level with or below the seat back or headrest.

NOT SUITABLE FOR USE

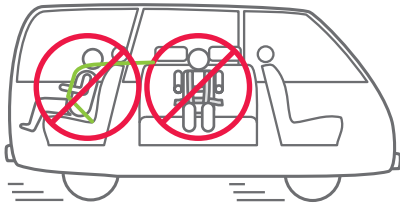

Do not use on any vehicle seat which faces sideways or rearwards.

PARTS SUPPLIED IN THE PACKAGE:

- Protecta PLUS™ Harness
- Anchor fitting, bolt and spacers.
- Adjustable Extension Strap
- Gated 3 bar slide
- Instruction Booklet

USING WITH A BOOSTER SEAT OR CONVERTIBLE BOOSTER SEAT

The Protecta PLUS™ Harness is suitable for Booster Seats and Convertible Booster Seats for seating positions where a child restraint anchorage is provided. Refer to the car's owners manual for positions. If an anchor fitting is required refer to pages 31 to 34. The following instructions provide details of how the Harness can be used with a typical Booster Seat. The Protecta PLUS™ Harness has the means for the harness straps feeding through the slots in the seat or over the top of the seat in accordance with the Seat's instructions. If you have a compatible Booster Seat or Convertible Booster seat without Versa-Tether™ connection then refer to the connection method on pages 13 & 14. If your seat has a Versa-Tether™ connection refer to pages 11 & 12.

These instructions provide details for installing the Child Harness with a Booster seat for either a lap only seat belt or a lap-sash seat belt.

CAUTION:

ALWAYS FOLLOW THE BOOSTER SEAT OR CONVERTIBLE BOOSTER SEAT INSTRUCTIONS AND LABELLING.

INSTALLING THE HARNESS TO THE BOOSTER SEAT OR CONVERTIBLE BOOSTER SEAT WITH SLOTS FOR CHILD HARNESS

Booster Seats and Convertible Booster Seats fitted with the Versa Tether™ connection system may require the Protecta PLUS™ Harness to be threaded through slots in the seat. Follow the seat's instructions. The following are general instructions.

Decide which seating position you are going to use and which seat belt type is installed in that position (if using a lap-sash seat belt then a Gated Slide must be used).

- Ensure any headrest is set to the correct height for your child.
- Hook the attachment clip to the anchor fitting and tighten.



HOW TO INSTALL & USE

- C. Lengthen the Child Harness using the adjuster under the cover (see the Child Harness instructions on the adjustment method). Press the Adjuster button (1) on the adjuster and pull the shoulder strap (2). **Right and left hand are referenced as seen by the child in the seat.**

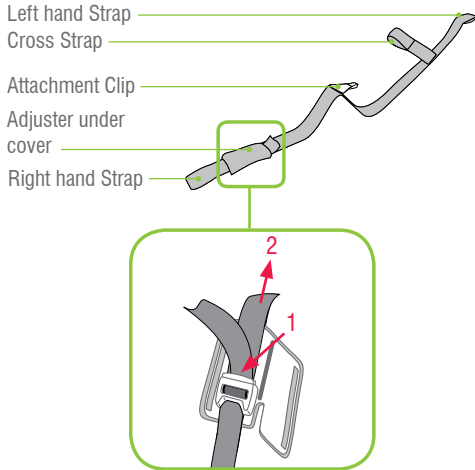

- D. Feed the left hand harness strap and attachment clip through the right hand slot of the booster seat headrest or seat cover. (Refer to the seat's instruction book).

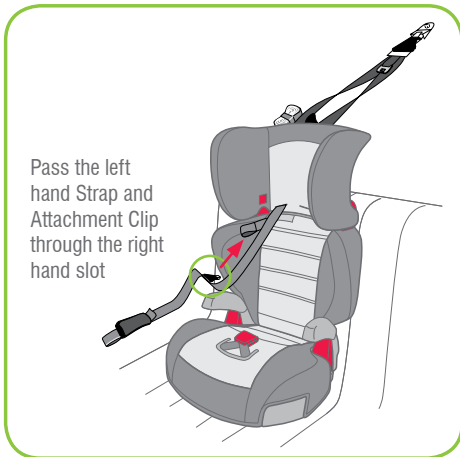

HOW TO INSTALL & USE

- E. Hook the Attachment Clip from the Child Harness onto the Versa-Tether™ Catch, then pass the left hand harness strap through the left hand slot of the booster seat. Page 11 shows connection of the Child Harness to the anchor fitting on the parcel shelf. Page 12 shows connection of the Child Harness to the extension strap and then the anchor fitting in the car such as a wagon or hatchback.



NOTE:

The straps must be in the slots provided in the headrest or seat cover to provide the best fit for the child. The shoulder straps must be nearest to the child's shoulder's but not be lower than the child's shoulders.

- F. The seat is now ready to fit the seat belt and the Child Harness to the child.

For attachment of Upper anchorage strap:

Refer to pages 11 & 12 - For Booster seat **with** Versa-Tether™ Catch system.

Refer to pages 13 & 14 - For Booster seat **without** Versa-Tether™ Catch system.

Refer to pages 15 & 16 - For converting a lap-sash seat belt.

Refer to pages 17 to 21 - For fitting the Child Harness with either a lap or converted lap-sash seat belt.

- G. If your seat is a Convertible Booster Seat the next page shows a similar method of setting up the seat.

NOTE:

If your Booster Seat or Convertible Booster Seat does not have a Versa-Tether™ connection, then you will need to follow the instructions on page 13 and fit the Child Harness first, then the seat's Upper Anchorage Strap.

WITH BOOSTER SEAT

WITH BOOSTER SEAT

HOW TO INSTALL & USE

FITTING Protecta PLUS™ HARNESS TO CONVERTIBLE BOOSTER SEATS FITTED WITH THE VERSA-TETHER™ SYSTEM.

- A.** Feed the left hand Harness Strap & Cross Strap through the appropriate shoulder slot for your child's size.

If the seat is fitted with an Adjustable Headrest then thread the harness through the slots in the headrest. (Refer to the seat's instruction book for full details).

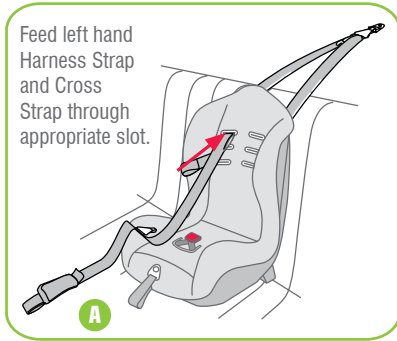

- B.** Pull the left hand Harness Strap & Cross Strap through the opposite shoulder slot. Make sure that the Anchor Clip also feeds through to the back of the restraint. Hook the Attachment Clip onto the Versa-Tether™ Catch and ensure that the straps line up to an equal length.

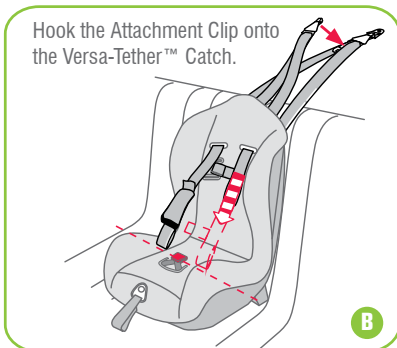

- C.** These are generic instructions so reference to the instructions for the Convertible Booster Seat is essential. Some Convertible Booster Seats may have an adjustable headrest. The previous pages may provide a guide for installation.

HOW TO INSTALL & USE

INSTALLING INTO VEHICLE WITHOUT EXTENSION STRAP

Hook the Child Harness attachment clip (1) onto Versa-Tether™ Catch (2). Then hook attachment clip (3) onto anchor fitting. Ensure that none of the straps are twisted and not passing over any sharp edges.

1. Attachment Clip from Child Harness.
2. Versa-Tether™ Catch.
3. Booster seat Attachment Clip.
4. Anchor Fitting in the car.

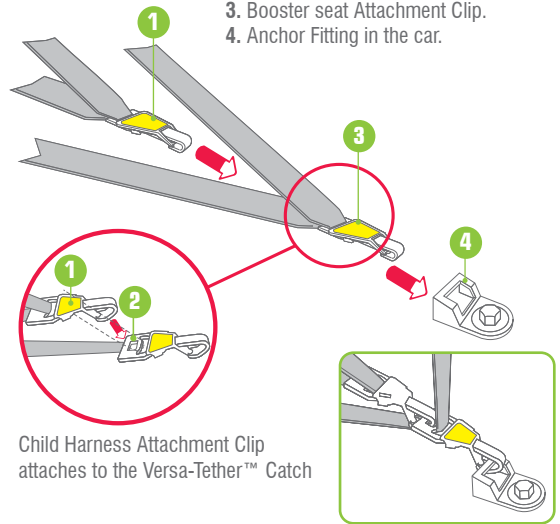

NOTE:

Do not use the Versa-Tether™ catch on the Child Harness Clip (1). Versa-Tether™ catch (2) is only for use with a Child Harness.

Alternative Versa-Tether™ System

Older Booster Seats and convertible booster Seats may have a strap for connecting the Child harness.

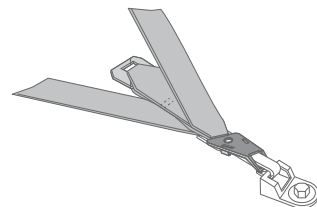

HOW TO INSTALL & USE

INSTALLING INTO VEHICLE WITH EXTENSION STRAP

An Adjustable Extension Strap is supplied with the Harness. Hook the Safe-n-Sound Protecta™ Harness clip first onto the extension strap catch, then hook the extension strap hook onto the Versa-Tether™ Catch on the Booster Seat's upper anchorage strap as shown below. Remove excess slack from the Extension Strap by pulling the adjuster strap as illustrated below.

1. Attachment clip from the Child Harness
2. Versa-Tether™ Catch
3. Booster Seat Attachment Clip
4. Anchor Fitting in the Car
5. Adjustable Extension Strap
6. Extension Strap Catch
7. Extension Strap Attachment Clip

Attachment Clip attaches to the Versa-Tether™ Catch

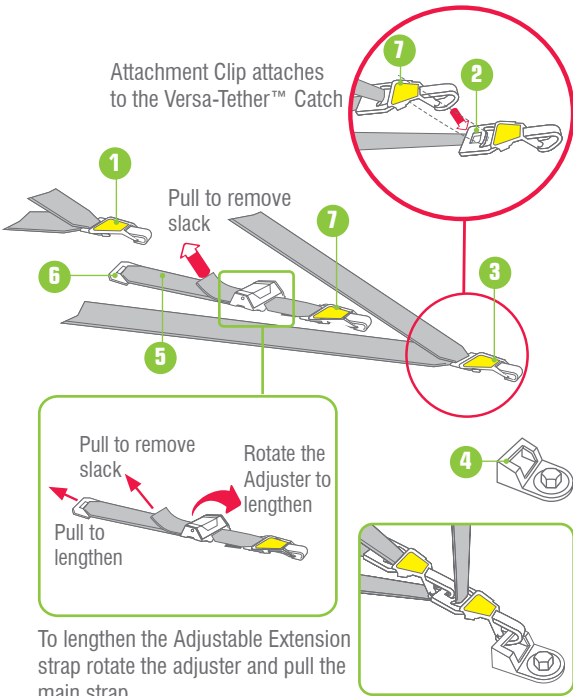

To lengthen the Adjustable Extension strap rotate the adjuster and pull the main strap.

WARNING:

Always attach the hook and remove the slack.

HOW TO INSTALL & USE

ALTERNATIVE TETHER CONNECTION WITH BOOSTER SEATS

Some compatible Booster Seats and Convertible Booster Seats may not have a Versa Tether™ connection facility. These seats can still be connected and use the Protecta PLUS™ harness.

The Attachment Clip on the Booster Seat or Convertible Booster Seat is connected to the Versa-Tether™ connection on the Child Harness Attachment Clip.

Fit the anchor fitting to the car's parcel shelf or just behind the car's seat so connection can be made without an Extension Strap. If the car is a Hatchback or Wagon the Extension Strap may be required.

Hook the Booster Seat Attachment Clip onto the Versa-Tether™ Catch on the Child Harness Clip.

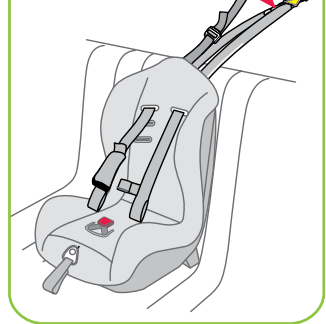

ALTERNATIVE INSTALLATION INTO VEHICLE WITHOUT EXTENSION STRAP

Hook the Child Harness attachment clip (3) onto the anchor fitting in the car (4). Then hook the Booster Seat Attachment Clip (1) onto the Versa-Tether™ Catch (2) and adjust to remove the slack. Once connected fit the Harness to the child - refer page 17.

1. Attachment Clip from Booster Seat.
2. Versa-Tether™ Catch.
3. Child Harness Attachment Clip.
4. Anchor Fitting in the car.

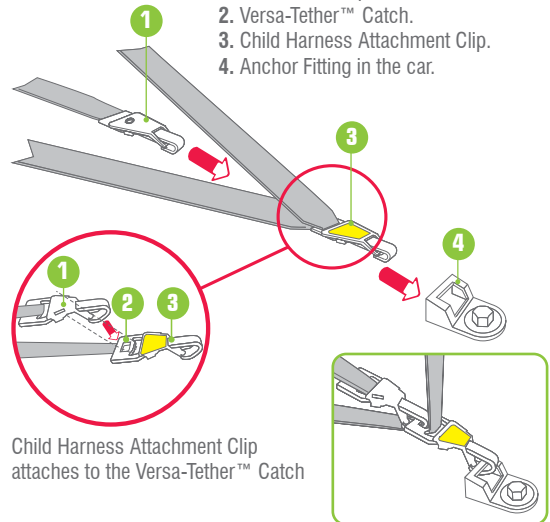

HOW TO INSTALL & USE

ALTERNATIVE INSTALLATION INTO VEHICLE WITH EXTENSION STRAP

An Adjustable Extension Strap is supplied with the Child Harness. Hook the Protecta PLUS™ Harness clip first onto the extension strap catch, then hook the extension strap hook onto the Versa-Tether™ Catch on the Booster Seat's upper anchorage strap as shown below. Remove excess slack from the Extension Strap by pulling the adjuster strap as illustrated below.

1. Attachment clip from the Booster Seat
2. Versa-Tether™ Catch
3. Child Harness Attachment Clip
4. Anchor Fitting in the Car
5. Adjustable Extension Strap
6. Extension Strap Catch
7. Extension Strap Attachment Clip

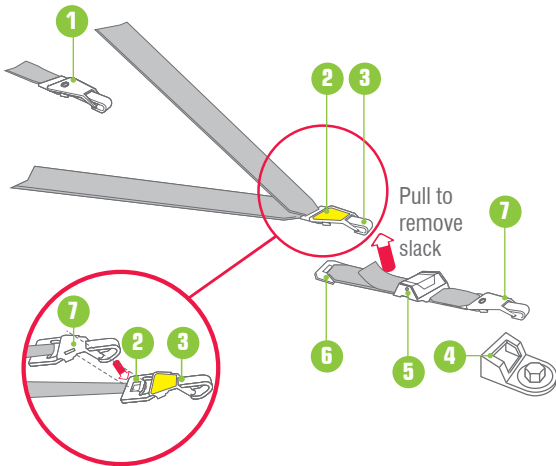

Attachment Clip attaches to the Versa-Tether™ Catch

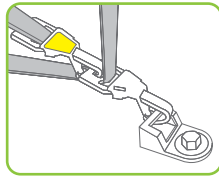

HOW TO INSTALL & USE

FOR USE WITH A LAP-SASH SEAT BELT AND BOOSTER SEAT

There may be one of two types of Gated Slides available as shown below provided with this harness. Only use Gated Slides recommended for this Harness.

If curved Gated Slide, then the belt route through this can only go one way as shown.

Before using the Protecta PLUS™ Harness with a Lap-Sash Seat Belt, you need to convert the seat belt to a Lap Seat Belt by using the Gated Slide provided.

IMPORTANT: Face the hollow side of the Gated Slide towards the child. Do not use Gated Slide for any other purpose.

Curved

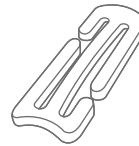

Flat

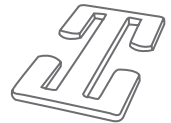

Always ensure the Hollow side is towards child

A. Hold the lap and sash straps together and fold as shown below. Slide the inner strap into the Gated Slide followed by the outer strap.

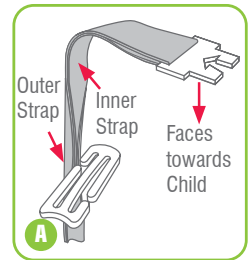

WARNING:

Always attach the hook and remove the slack.

HOW TO INSTALL & USE

B. The two straps should slide freely in the Gated Slide slot.

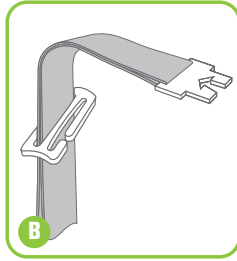

C. Repeat previous step A for the other slot in the Gated Slide.

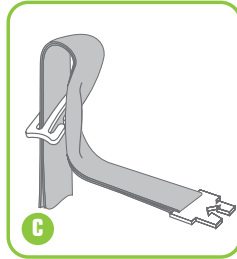

D. Feed the straps through the Gated Slide to remove any slack. This has now converted the lap-sash seat belt so it will act like a lap only seat belt.

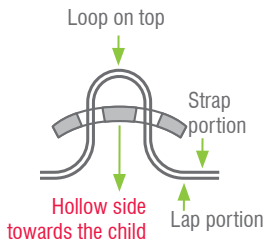
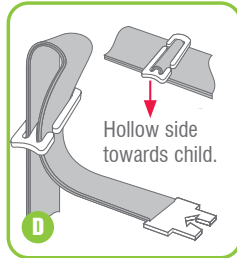

TO ENSURE CORRECT CONVERSION OF LAP-SASH SEAT BELT TO LAP SEAT BELT FOLLOW THESE STEPS.

IMPORTANT:

The Gated Slide must be removed from the seat belt if the booster seat and child harness are no longer used in the car so that other users can use the seat belt as a lap sash seat belt.

A seat belt extender should not be used if the seat belt is not long enough to secure the child. If a seat belt extender is used then the buckle must not be in contact with the child.

HOW TO INSTALL & USE

HARNESING THE CHILD INTO THE BOOSTER SEAT

These instructions apply to fitting with a lap only seatbelt or a converted lap-sash seatbelt.

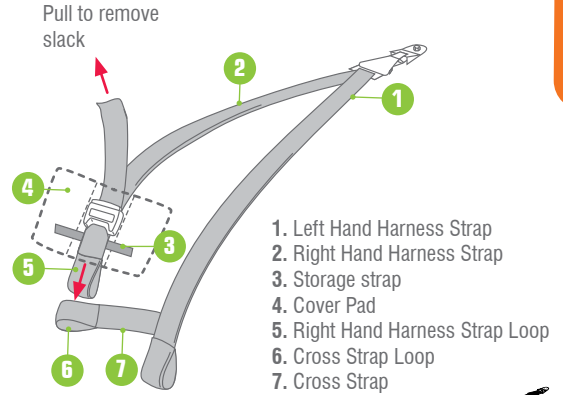

A. With the child seated, place each of the harness straps over each shoulder.

B. Feed the right hand strap (loop end) into the cross strap loop to connect the two sides.

C. Feed the adult belt (lap belt or converted lap/sash) through the harness loops, ensuring that the cross strap loop does not disconnect. Also ensure there are no twists in the harness, cross strap and seat belt.

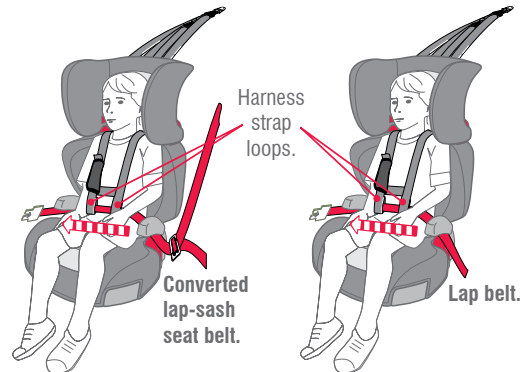

Thread the converted lap-sash seat belt or lap seat belt through the harness strap loops as shown.

HOW TO INSTALL & USE

D. Engage the seat belt tongue to the buckle and adjust the seat belt to sit firmly around the child's hips and thighs. The seat belt buckle should be located as low as possible below the child's hip. If using a lap-sash seatbelt and Gated Slide you will need to adjust it so that the seatbelt is firm on the child's thighs and the Gated Slide is close to the Child but not touching the child.

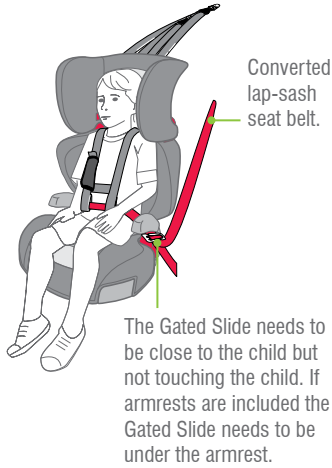

SLIDEGUARD™ clip

E. Fit the SLIDEGUARD™ clip if fitted on the seat.



F. Then adjust the Protecta PLUS™ Harness to remove all slack in the shoulder straps. Do not over tighten so as to cause the seatbelt to lift off the child's thighs. As the child grows this front adjuster will need to be adjusted.

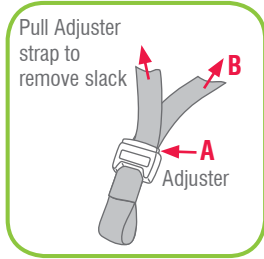

Fully press adjuster button (A) while pulling the Upper Anchorage Strap (B) to lengthen.

HOW TO INSTALL & USE

G. Finally, roll up the free end of the adjuster strap, secure using the storage strap, then place it into the top of the adjuster cover as shown above.

Fold up excess strap and store with the storage strap and close cover.

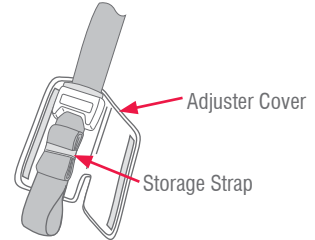

H. To release the child, see page 22. In some installations the seatbelt may need to be taken out of the Strap Loops.

FITTING Protecta PLUS™ HARNESS ONTO BOOSTER SEATS & BOOSTER CUSHIONS

If using the harness with a Booster seat or Convertible Booster Seat where there are no slots for the child harness, the child harness will need to be fitted as per the seats instructions. This may require the harness to be placed over the top of the seat and the harness may be threaded through a guide if possible.

A. With Booster seats and Booster Cushions the Protecta PLUS™ Harness shoulder straps sit over the top of the seat back or the car's seat back as shown in the diagram on the right.



B. Hook the Child Harness Attachment Clip to the anchor fitting.

C. Pull the left hand and right hand Harness Straps so that they are equal in length.

D. Follow installation instructions on 17 and 18 for how to fit the car's seat belt to the Protecta PLUS™ Harness.

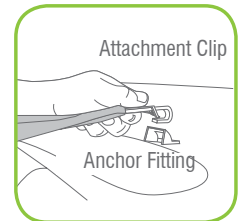

WITH BOOSTER SEAT

HOW TO INSTALL & USE

Protecta PLUS™ HARNESS WITH BASIC BOOSTER AND BOOSTER CUSHION

USING LAP SASH SEATBELT

Thread the converted lap-sash seat belt through the harness strap loops as shown.

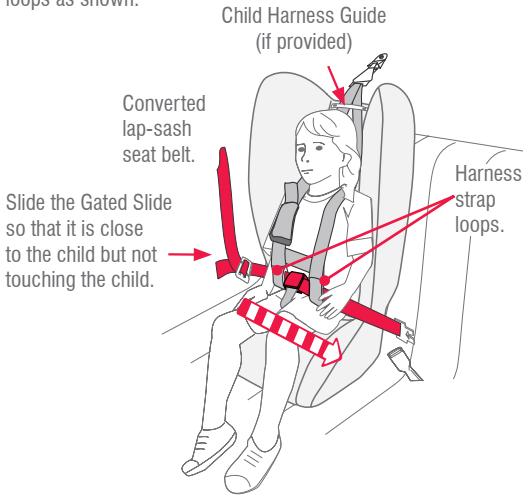

USING LAP ONLY SEATBELT

Thread the lap seat belt through the harness strap loops as shown.

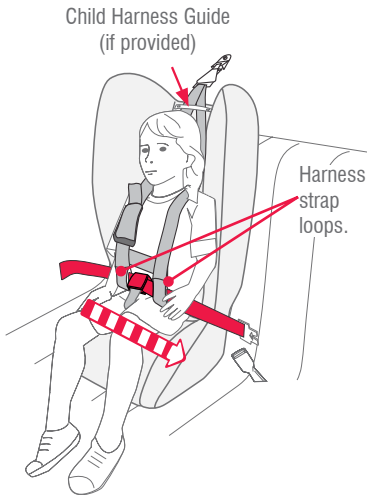

HOW TO INSTALL & USE

WITH BOOSTER SEAT

Thread the harness through any guides or slots on the booster seat, (refer to booster seat instructions).

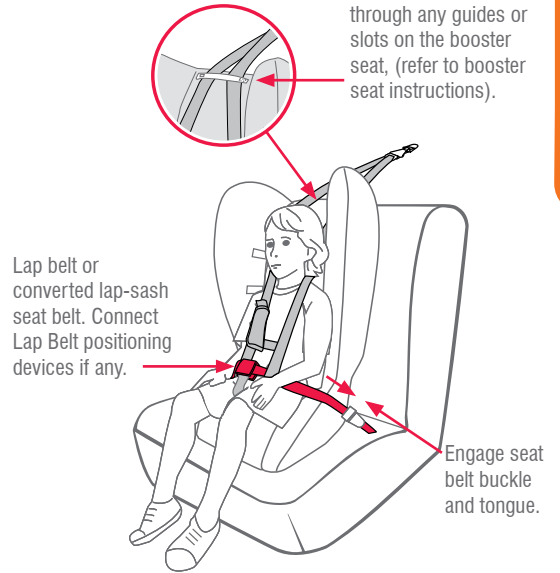

USE WITH A BOOSTER CUSHION

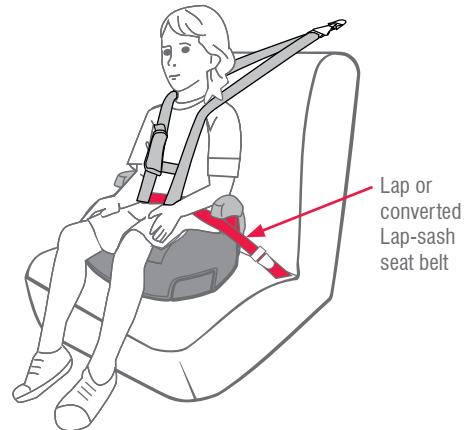

Shoulders must not be above the top of the car's seat back.

NOTE: REFER TO PAGE 19 ADJUSTING CHILD HARNESS

WARNING:

DO NOT LEAVE CHILDREN UNATTENDED IN THE CAR.

HOW TO INSTALL & USE

TO REMOVE CHILD FROM HARNESS AND SEAT

Disengage seat belt tongue and buckle, remove the lap portion of seat belt from the SLIDEGUARD™ clip (where provided) and remove Child Harness and seatbelt from child.

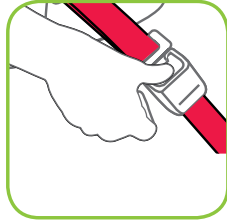

NOTE:
It maybe easier to unthread the car seat belt out of the loops before lifting the child harness over the child's head.

Lift child harness strap over child's head.



Once the child is too large for the booster seat, the Child Harness can then be used with a lap only seat belt on the car's seat. A Child Harness is a significant safety device for children in a lap only seat belt. Refer to the following pages.

HOW TO INSTALL & USE

USING THE HARNESS WITH THE CAR'S SEAT AND SEATBELT

This mode is used after the child has finished using a Booster Seat or Convertible Booster Seat because their shoulders were in line with the Upper Shoulder Height Marker. If you have not already done so, check your car owner handbook for the location of the car's child restraint anchor fitting. If there is no anchor fitting then read pages 31 to 34.

When installing the Protecta™ PLUS Harness into the vehicle connect the upper anchorage strap to the anchor fitting on the parcel shelf.

Use the Adjustable Extension Strap for all other instances requiring a longer strap to attach the harness to anchor points in the vehicle floor or roof (See the following page).

INSTALLING INTO VEHICLE WITHOUT EXTENSION STRAP

Hook attachment clip onto anchor fitting. Ensure that none of the straps are twisted or catching on sharp edges.

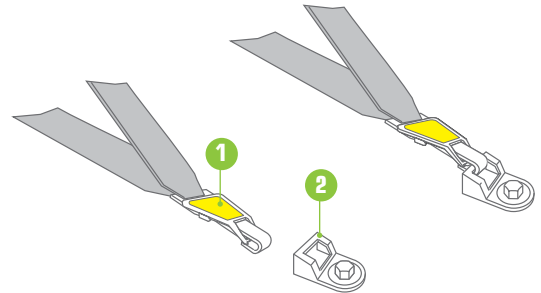

1. Child Harness Attachment Clip.
2. Anchor Fitting in the car.

WITH CAR'S SEAT

HOW TO INSTALL & USE

INSTALLING INTO VEHICLE WITH AN EXTENSION STRAP

Hook attachment clip onto anchor fitting in the car. Ensure that none of the straps are twisted or catching on sharp edges. Then connect the harness Attachment Clip to the Extension Strap Catch. Remove excess slack from Adjustable Extension Strap pull the adjusting strap (6) as illustrated below.

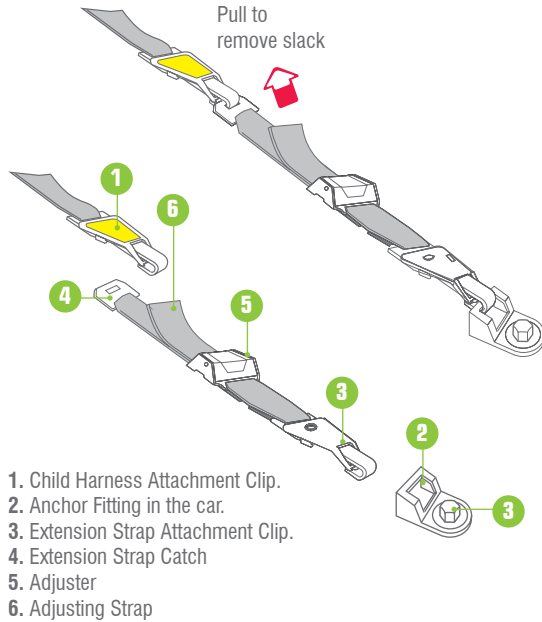

1. Child Harness Attachment Clip.
2. Anchor Fitting in the car.
3. Extension Strap Attachment Clip.
4. Extension Strap Catch
5. Adjuster
6. Adjusting Strap

To lengthen the Adjustable Extension strap rotate the adjuster and pull the main strap.

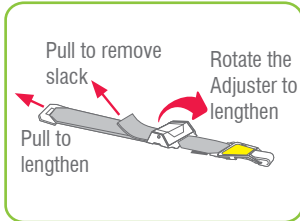

WARNING:

Always attach the hook and remove the slack.

HOW TO INSTALL & USE

IMPORTANT:

If you have used the Harness with a Lap-sash Seat belt, then the Gated Slide must be removed from the seat belt if the booster seat and harness are no longer used in the car so that other users can use the seat belt as a lap sash seat belt.

A seat belt extender should not be used if the seat belt is not long enough to secure the child. If a seat belt extender is used then the buckle must not be in contact with the child.

A Connect the Protecta PLUS™ Harness Attachment Clip to the Child Anchorage fitting in the car as described on the previous pages. Open the cover pad (4), remove the strap from the storage band.

1. Left Hand Harness Strap
2. Right Hand Harness Strap
3. Storage Strap
4. Cover Pad
5. Right Hand Harness Strap Loop
6. Cross Strap Loop
7. Cross Strap

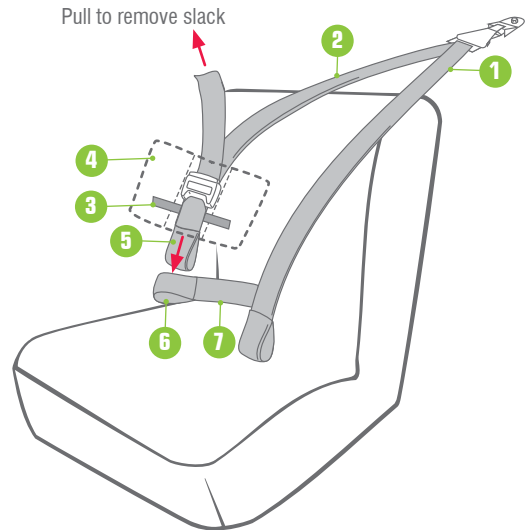

B. Fully press Adjuster Button (B1) while pulling the Upper Anchorage Strap (B2) to lengthen. Pull adjuster strap (B3) to remove slack.

C Fit the Right hand Strap Loop (5) to the Cross Strap Loop (6).

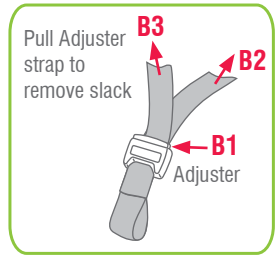

WITH CAR'S SEAT

HOW TO INSTALL & USE

- D Thread the lap seat belt through the harness strap loops as shown. If you are using a Lap-sash seat belt, refer to page 15 and 16 for converting the seat belt.

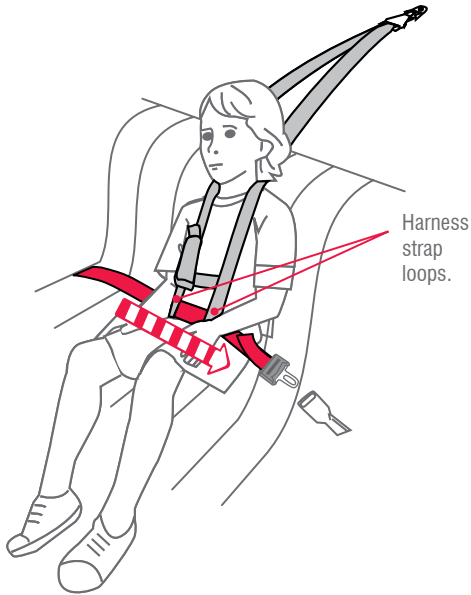

- E. Engage Seat belt buckle and Tongue. Tighten the lap seat belt so that it fits firmly on the child's thighs. **The child must not slump or slouch such that the seat belt rides up on the abdomen or tummy of the child.**

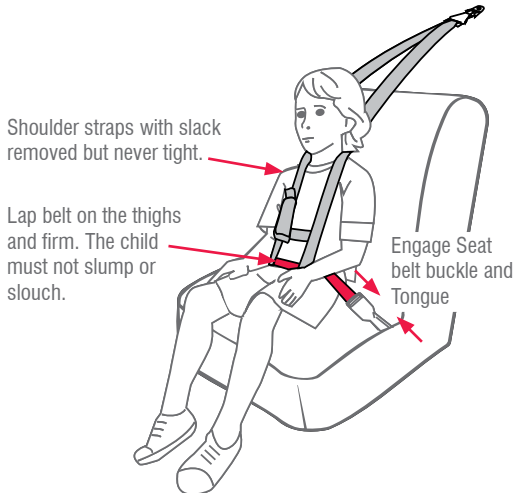

HOW TO INSTALL & USE

- F. Adjust the harness by pulling the adjuster strap (B3) to remove slack but do not tighten (see page 25).

Pull adjuster strap to remove slack



- G. Fold up excess strap and store with the storage strap and close the cover.

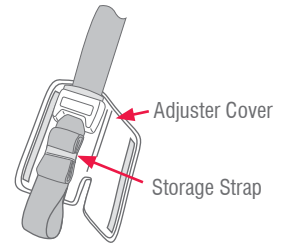

IMPORTANT:

The harness straps must always be fitted on each side of the child's neck.

When not in use, the Protecta PLUS™ Harness may be flipped onto the parcel shelf or disconnected from the anchor fitting and stored.

WARNING:

DO NOT LEAVE CHILDREN UNATTENDED IN THE CAR.

The lap portion of the belt must be adjusted firmly first, and then the harness, so that the belt is not lifted off the child's lap when the harness is adjusted.

- H. Attachment clip and catch must be behind the seat back and away from your child's head. If this is not the case either shorten or remove the Extension Strap.

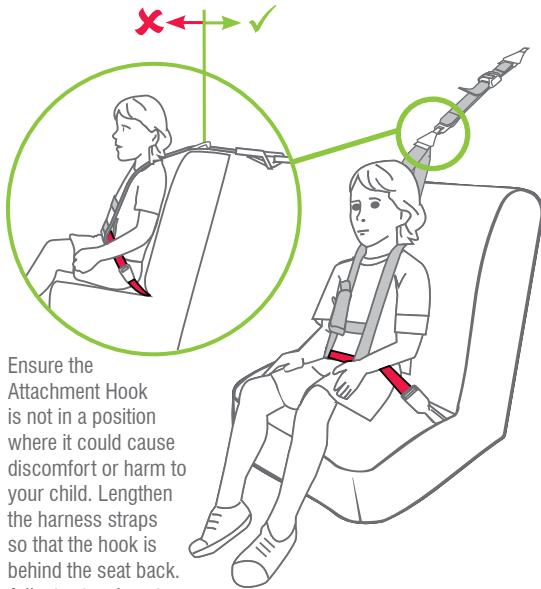

Ensure the Attachment Hook is not in a position where it could cause discomfort or harm to your child. Lengthen the harness straps so that the hook is behind the seat back. Adjust extension strap to remove slack.

TO REMOVE CHILD FROM THE HARNESS

To remove the child from the car, release the seatbelt buckle and then take the Harness and seatbelt over the child's head. The Harness can be refitted the next time without adjusting the Harness. Review the fitting from time to time but always ensure the Harness is correctly adjusted.

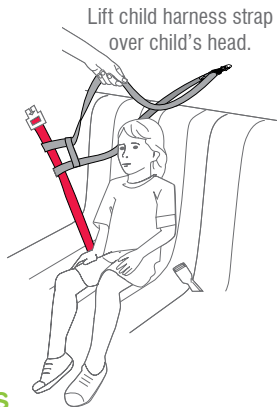

TO REMOVE HARNESS FROM VEHICLE

- Feed seat belt out through Child Harness.
- Disconnect the attachment clip from the car.
- Remove the Gated Slide if used, from the seat belt so an adult may use the belt.

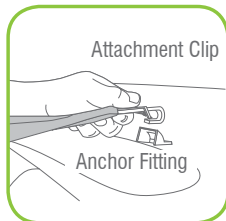

Protecta PLUS™ HARNESS AND BOOSTER SEAT

If the seat is fitted with a Lap Belt Positioning Device like SLIDEGUARD™ clip, always use it. They will prevent the child slumping or the seatbelt riding up on to the child's abdomen.

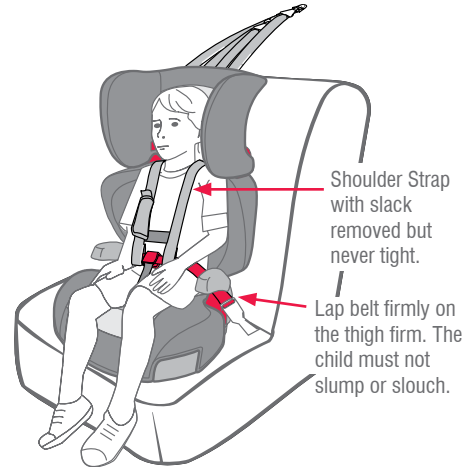

! CAUTION:

ALWAYS FOLLOW THE BOOSTER SEAT OR CONVERTIBLE BOOSTER SEAT INSTRUCTIONS AND LABELLING. FOLLOW SEAT BELT PATHS.

Protecta PLUS™ HARNESS AND CAR'S SEAT BELT

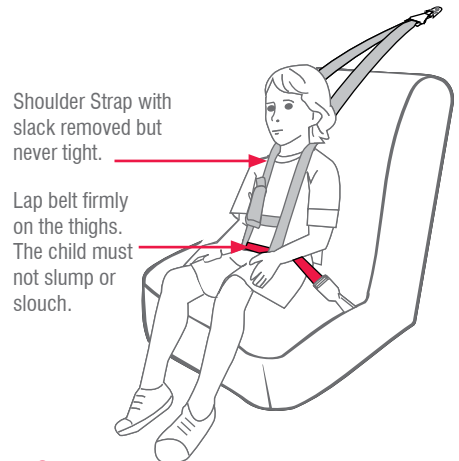

! IMPORTANT:

The harness straps must always be fitted on each side of the child's neck.

NEXT TYPE OF RESTRAINT THAT CAN BE USED IN THE CAR FOR YOUR CHILD.

If you are using a booster seat and the child's shoulders have reached the top height marker then you can use just the child harness and the lap only seat belt.

When the child reaches 36kg then they need to discontinue using the child harness, and use just the car's seat belt.

If using the harness on the car's seat discontinue using the harness when the child's shoulders reach the top of the car's seat or the car's headrest.

EACH REGION HAS ROAD RULES THAT REQUIRE A CHILD TO BE PROPERLY RESTRAINED. ALWAYS FOLLOW THE RULES.

If you have outgrown the booster seat then you can use a Child Harness and car's lap only seat belt

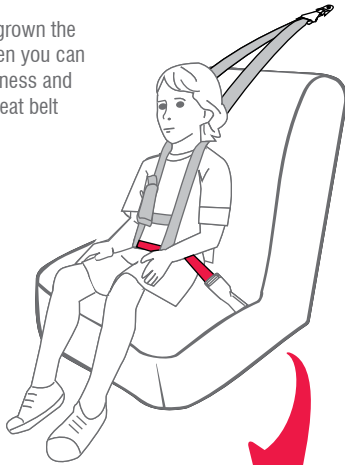

If the child is over 36kg then they can just use the car's seat belt. The seat belt must be correctly fitted.

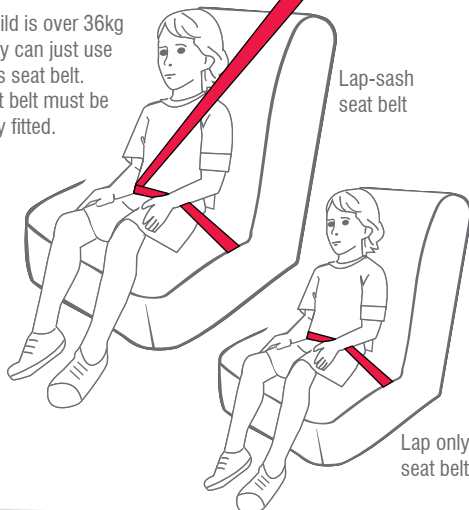

Consult the vehicle owner's handbook for location of anchorage fittings or anchorage points and the possible use of spacers. Some vehicles may have an anchor fitting fitted by the vehicle manufacturer. If anchorage points cannot be found refer to car manufacturer or local child restraint fitting station or traffic authority for optimum position of anchorage point and the use of spacers.

UPPER ANCHORAGE STRAP



THE ATTACHMENT CLIP COVER MUST ALWAYS BE USED AS IT PREVENTS THE RISK OF INCORRECT FITMENT OF THE ATTACHMENT CLIP TO THE ANCHOR FITTING. ALWAYS ENSURE THAT THE ATTACHMENT CLIP IS CORRECTLY ENGAGED TO THE ANCHOR FITTING AND NOT HOOKED OR FITTED TO ANY OTHER OBJECT BEFORE EACH USE OF THE RESTRAINT. THIS IS ESPECIALLY IMPORTANT IN VEHICLES SUCH AS STATION WAGONS, VANS, HATCH BACKS OR VEHICLES WITHOUT A FIXED PARCEL SHELF, SINCE THE ANCHOR POINT IS USUALLY NOT VISIBLE.

IMPORTANT INSTALLATION NOTE:

In some vehicles the anchor fitting in the rear vertical panel can only be installed in one way. Please refer to vehicle owner's handbook or a child restraint fitting station for correct method.

Extension Strap distance to be measured.
 Length 300mm (Use Safe-n-Sound part 0035 or equivalent)
 Length 600mm (Use Safe-n-Sound part 0036 or equivalent)
 Available from all major child restraint retailers.

The diagram shows a side view of a car's rear passenger area. A child is seated in a booster seat. An adjustable upper anchorage strap is shown extending from the booster seat to an anchor fitting on the rear vertical panel. A 45-degree angle is indicated between the strap and the vertical panel. A red circle highlights the attachment clip, with a callout showing a close-up of the clip correctly engaged with the anchor fitting. A red arrow points from the text 'CORRECT ENGAGEMENT OF ATTACHMENT CLIP TO ANCHOR FITTING' to this callout. A red arrow also points from the text 'DISTANCE TO MEASURE TO THE ANCHOR POINT' to the length of the strap.

The shaded areas of this diagram illustrate the possible locations of the anchor fitting. Within each shaded area is an anchor fitting showing the correct way to install the fitting. Ensure the anchor fitting is aligned as illustrated unless stated otherwise in the vehicle owner's handbook.

PRE-INSTALLATION ANCHOR FITTING

IF THE CAR IS FITTED WITH CHILD RESTRAINT ANCHORAGE POINT

Locate the anchorage point behind the rear seating position. (consult the car owners handbook for the location of the anchorage point). The anchorage point should be directly behind and central to the restraint. Remove thread plug from the parcel shelf/floor/roof, etc. and install anchor bolt and fitting as shown in Fig.1.

CAUTION: DO NOT OVERTIGHTEN ANCHOR BOLT. OVERTIGHTENING MAY FRACTURE OR BREAK BOLT. MAXIMUM TORQUE IS 20 Nm (14.75 ft.lb.)

Note: Minimum of five full turns of anchor bolt is required before tightening force is applied.

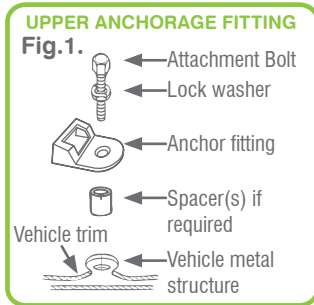

IF THE CAR IS NOT FITTED WITH CHILD RESTRAINT ANCHORAGE POINTS

For Sedans only - Drill 9mm diameter hole in the parcel shelf on the centre line of the seating position as shown in Fig.3. Before drilling the hole, check the underside for accessibility. Install the anchor bolt as shown in Fig.2.

For vehicles other than Sedans - In Australia, consult your nearest child restraint fitting station or traffic authority for vehicle inspection to find the best, correct position for the placement of the anchorage point, and for the correct attachment bolt length and use of spacers. In New Zealand, consult the agent for the vehicle.

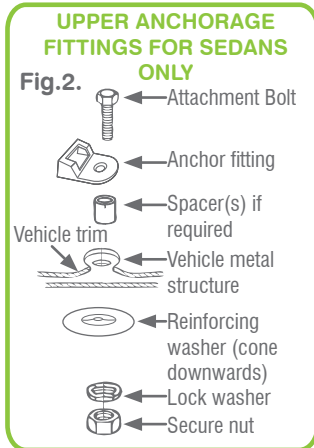

PRE-INSTALLATION ANCHOR FITTING

Note to Queensland purchasers: The installation of anchorage points must be approved by authorised officers appointed by Queensland Transport. Authorised officers can be sourced from all Queensland Transport Customer Service and Queensland Ambulance Service Centres.

ONLY USE A 5/16 UNC GRADE 5 BOLT. IF THE BOLT IS NOT THE CORRECT LENGTH THE CAR MANUFACTURER'S HAND BOOK CAN PROVIDE ADVICE ON THE CORRECT LENGTH BOLT.



Note: Marking on the top of a Grade 5 Bolt.

WARNING

CHILD RESTRAINTS MUST NOT BE ATTACHED TO UNSOUND METAL OR TO WOOD, OR SYNTHETIC STRUCTURES. WHEN DRILLING 9 MM HOLE DO NOT DRILL THROUGH FUEL LINES, FUEL TANKS, ELECTRICAL WIRING, OR RADIO SPEAKERS. WEBBING STRAPS MUST BE PROTECTED FROM SHARP CORNERS AND EDGES. THE ANCHOR FITTING MUST BE USED ONLY AS DESCRIBED ABOVE. IT MUST NOT BE HOOKED ONTO ANY OTHER OBJECT.

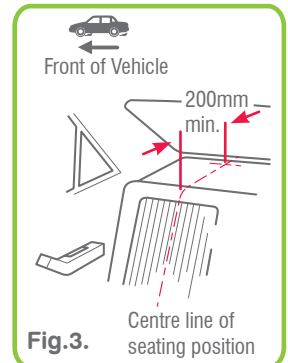

UPPER ANCHORAGE STRAP

IMPORTANT:

THE ATTACHMENT CLIP COVER (SEE FIGURE 4 ON THE PREVIOUS PAGE) MUST ALWAYS BE USED AS IT PREVENTS THE RISK OF INCORRECT FITMENT OF THE ATTACHMENT CLIP TO THE ANCHOR FITTING. ALWAYS ENSURE THAT THE ATTACHMENT CLIP IS CORRECTLY ENGAGED TO THE ANCHOR FITTING AND NOT HOOKED OR FITTED TO ANY OTHER OBJECT BEFORE EACH USE OF THE RESTRAINT. THIS IS ESPECIALLY IMPORTANT IN VEHICLES SUCH AS STATION WAGONS, VANS, HATCH BACKS OR VEHICLES WITHOUT A FIXED PARCEL SHELF, SINCE THE ANCHOR POINT IS USUALLY NOT VISIBLE.

The restraint strap & Attachment Clip may be damaged or disconnected by unsecured vehicle contents. To ensure a secure engagement, before each use of the restraint follow this procedure:

- A. Secure or remove any vehicle contents.
- B. Remove slack from the Upper Anchorage Strap and ensure that strap is not twisted. The strap does not need to be tight as it may lift the seat belt off the child's thighs.
- C. Make sure the Attachment Clip is correctly engaged.

VEHICLE INSTALLATION ACCESSORIES

(Available from retailers of Safe-n-Sound products)

EXTRA ANCHOR KITS: Are available if using the restraint in additional vehicles. Re-order number: 0038

EXTENSION STRAPS: May be required for vehicles without a fixed parcel shelf. Re-order number: 0035 (length 300mm) 0036 (length 600mm).

GATED 3-BAR SLIDE: For converting lap-sash seat belt to lap belt Re-order number: 0215 (one gated slide is provided with this Harness).

MAINTENANCE

Ensure all stitching and webbing are not fraying. Clean webbing with damp cloth and allow to dry.

Check the adjuster is operating correctly and locking onto the strap.

If your restraint has been involved in a severe crash, you should destroy the restraint even if no damage is obvious. Some insurance companies offer vehicle insurance which covers or partially covers the replacement of your child restraint. Contact your insurance company for further details.

Your insurance company may require you to keep the child restraint for assessment, **but do not use the child restraint after a severe crash**. To assist you in making an accident insurance claim cut the following statement and include it with your claim.

NOTICE TO INSURANCE COMPANY CHILD RESTRAINT INVOLVED IN AN ACCIDENT

All Safe-n-Sound child restraints are manufactured to Australian/New Zealand Standards AS/NZS1754-2010 which requires us to advise users of child restraints to "Destroy the entire restraint if it has been in use in a severe crash, even if no damage is obvious". The joint Australian/New Zealand Standards committee CS/85, advise that this statement applies whether a child was in the child restraint or not. We consider a "severe crash" as being one where the main body structure of the vehicle is distorted.

There is no method of determining if the restraint has been damaged and we concur with the Australian/New Zealand Standards in recommending destruction of the child restraint.

This notice is to advise you of the requirements of the Australian/New Zealand Standards and our obligation in complying with the standards.

Please assist the owner of this restraint in their claim.

Britax Childcare Pty. Ltd.

(Incorporated in Victoria)
A.B.N 55 006 773 600

Head office and registered address:

99 Derby Road Sunshine Victoria 3020

PO Box 147 Sunshine Victoria 3020

Telephone: 1300 303 330

www.britax.com.au

New Zealand Office

Britax Childcare NZ Limited.

Telephone: 0508 688 822

www.britax.com.nz



AUSTRALIA

Britax Childcare Pty. Ltd.
A.B.N 55 006 773 600

Head office and registered address

99 Derby Road, Sunshine, Victoria 3020.
PO Box 147 Sunshine, Victoria 3020.

Customer Service 1300 303 330

Email au-custserv@britax.com

www.britax.com.au

NEW ZEALAND

Britax Childcare (NZ) Ltd.

Customer Service 0508 688 822

Email nz-custserv@britax.com

www.britax.co.nz

INTERNATIONAL ENQUIRIES

Contact your local Distributor.

The Safe-n-Sound, Protecta, Protecta Plus, SLIDEGUARD and Versa-Tether trademarks are the property of Britax Childcare Pty. Ltd. (Australia).

The Britax trademark is the property of Britax Excelsior Limited (UK). We reserve the right to alter this product without notice.

© 2005-2010 Britax Childcare Pty. Ltd.

This product is covered by Australian and overseas Patent applications. Patents pending.

Protecta PLUS™ Child Harness

Series Number: 220/2010

The Protecta PLUS™ Harness can be used with all Booster Seats or Convertible Booster Seats that are suitable for use with this Series 220/2010 Child Harness and are fitted with a Versa-Tether™ connection

To be used only in a forward facing position.

For children aged approximately 4 to 7 years of age, the restraint should be used with a compatible booster seat and seat belt.

For children aged approximately 7 to 10 years of age, the restraint should be used either with a compatible booster seat and seatbelt, or on a vehicle seat with a lap only seat belt.

It is not recommended that this restraint be used on a vehicle seat with a lap-sash seatbelt.

Suitable for children up to 36kg. Suitable for use with a child on the car's seat until the child's shoulders are above the top of the car's seat back or headrest.

TO BE USED WITH A LAP-SASH OR LAP ONLY SEAT BELT IN THE BACK OF MOST CARS WITH FORWARD-FACING SEATS.

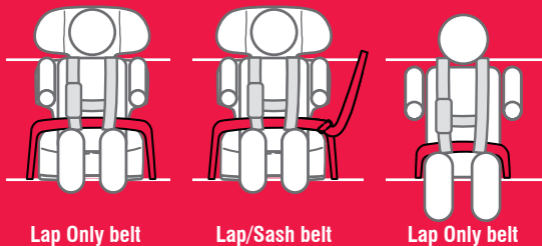

THIS RESTRAINT IS NOT SUITABLE FOR USE WHERE THE ANCHORAGE STRAP MAY FALL INTO A SPLIT IN THE SEAT BACK (E.G. HATCHBACK OR WAGON).

Do not use on any vehicle seat which faces sideways or rearwards.

THIS RESTRAINT MUST BE ATTACHED TO A CHILD RESTRAINT ANCHORAGE POINT IN THE CAR. REFER TO CAR OWNER'S HANDBOOK FOR LOCATION OF ANCHORAGE POINTS. REFER TO A CHILD RESTRAINT FITTING STATION IF NO ANCHORAGE POINTS ARE IN THE MOTOR CAR.

No child restraint can guarantee absolute protection from injury in every crash. However, to ensure that your child gets all the protection provided by the Protecta PLUS™ Harness read and follow the enclosed instructions exactly.

An Extension strap is provided with the Child Harness but additional Extension Straps may be required for vehicles without a fixed parcel shelf.

Re-order Numbers: 0035 (length 300 mm) or 0036 (length 600 mm) Spacers, if required, they are included in this package.

This package does not include an adult seat belt.